

POWER  
BUTTON

NETWORK  
PORT

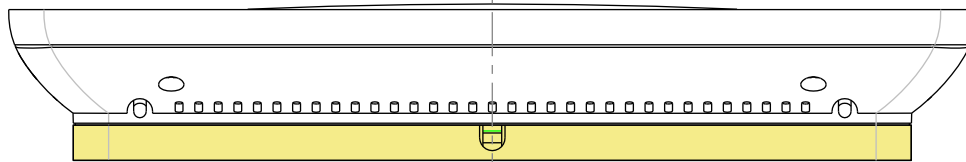

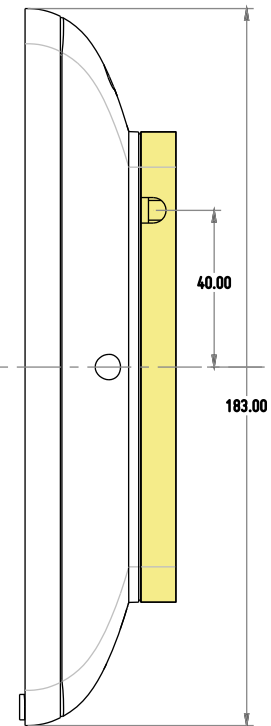

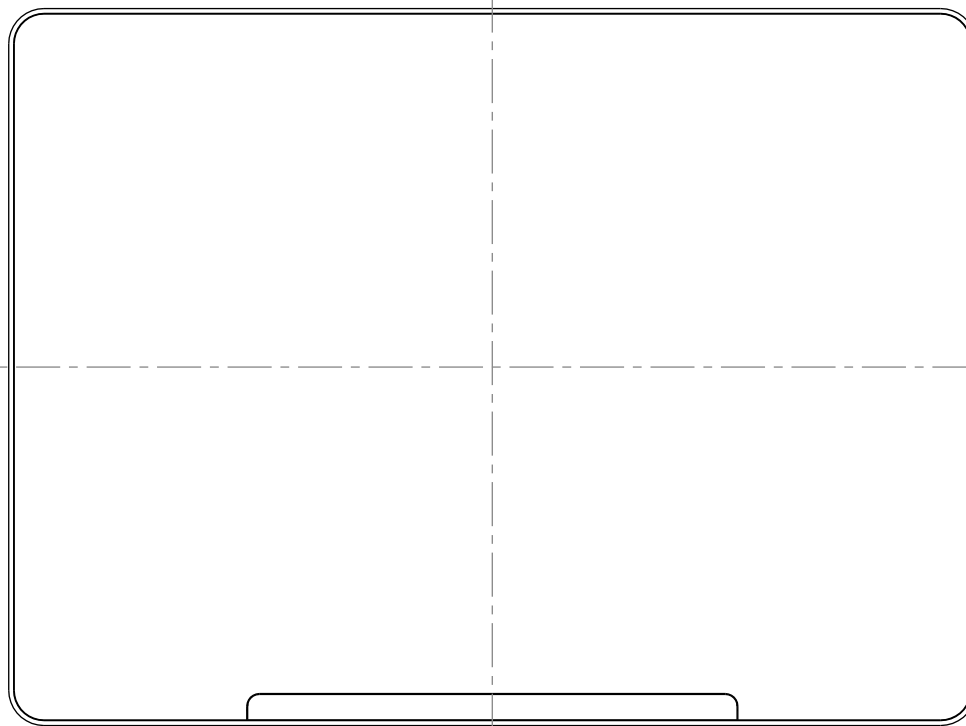
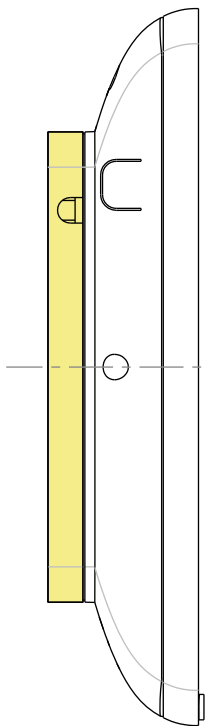
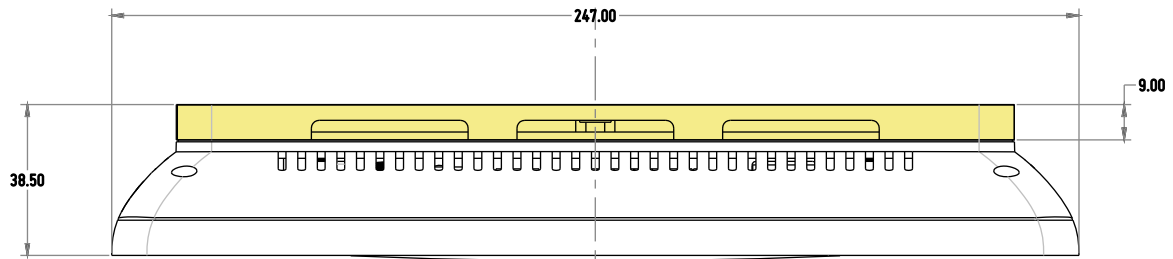
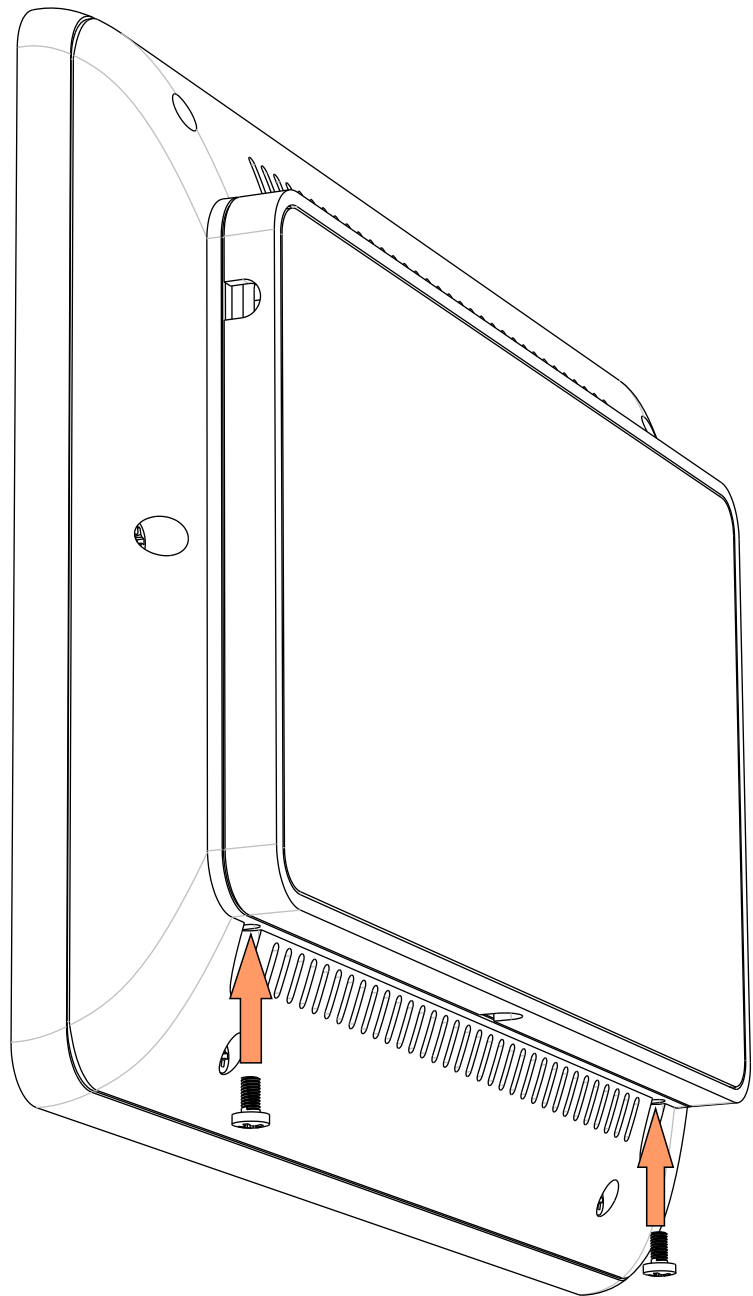



# Meeting Room 5A

09:50

Enter pin or swipe card below

Pin \_ \_ \_ \_ \_

0	1	2	3	4
5	6	7	8	9
A	B	C	D	E

Clear

× Cancel





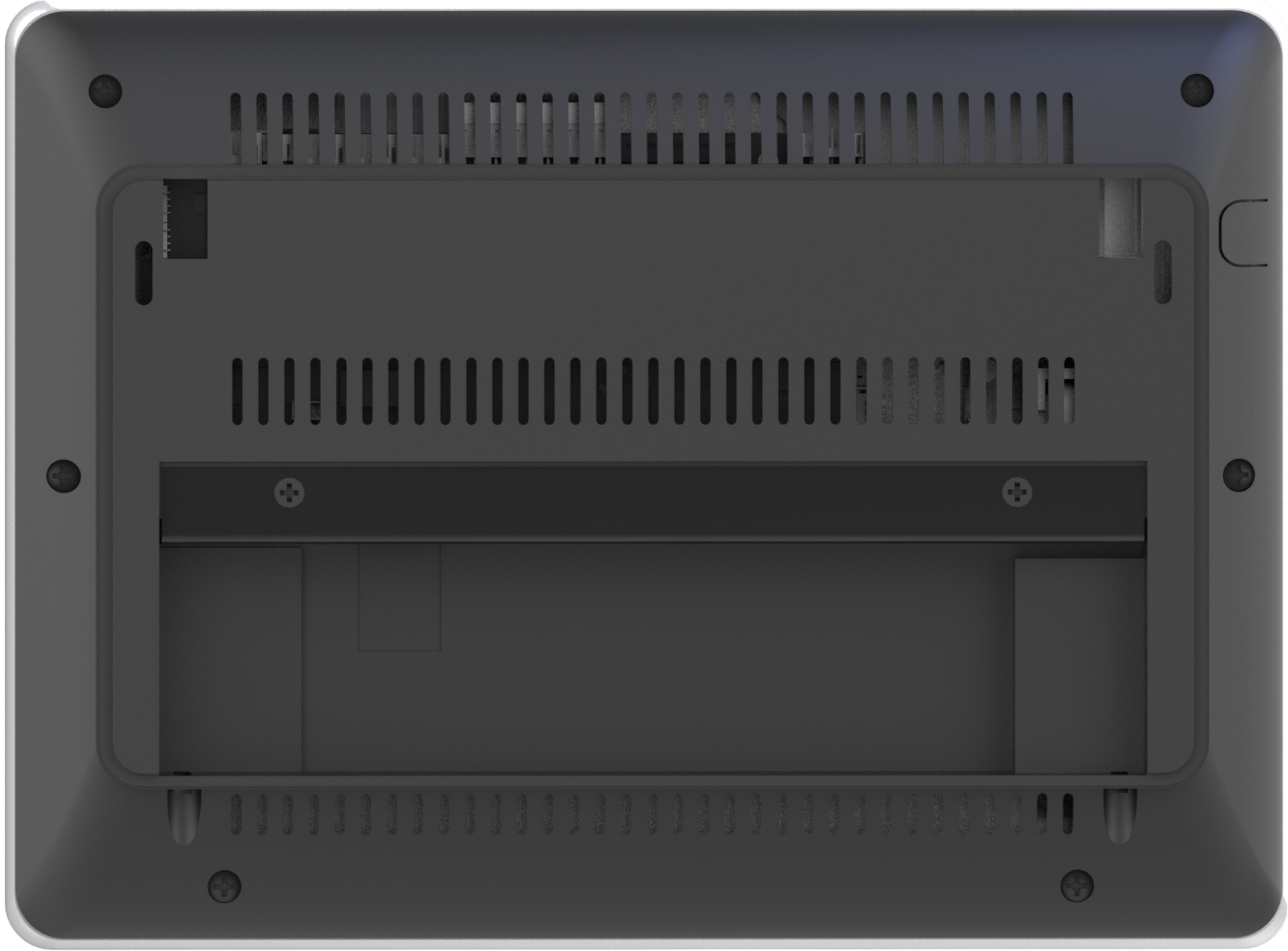





Meeting Room 5A

09:50

Enter pin or swipe card below

Pin \_\_\_\_\_

0	1	2	3	4
5	6	7	8	9
A	B	C	D	E

Clear

× Cancel

